

Model: MS 100-3

RL

IP65



Photo View



3D Rendered View

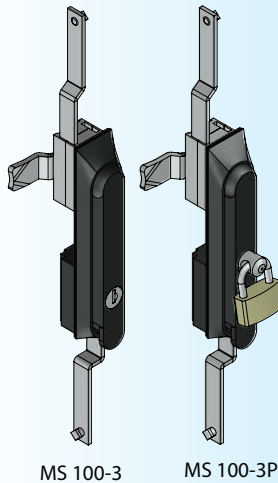

- ▶ MATERIAL: PA6 BODY, BRASS SHAFT, ZINC DIE CASTING ROD CONTROLLER BOX, ZINC PLATING FIXING PARTS
- ▶ FINISH: MATT BLACK

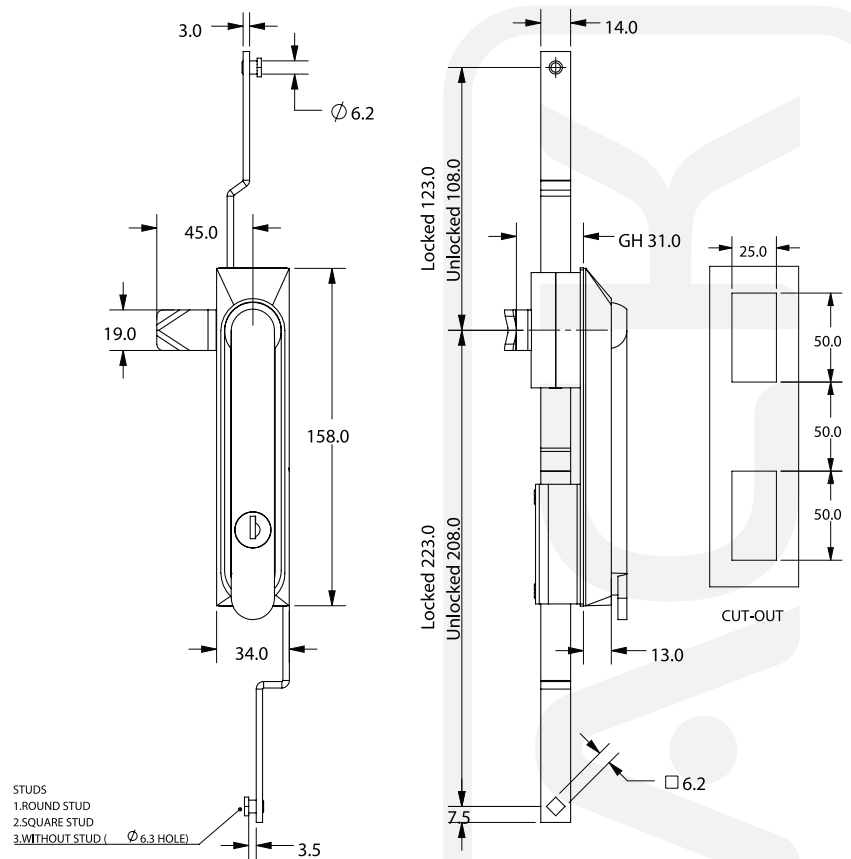

CENTER CAM OPTIONS

OPTION 1

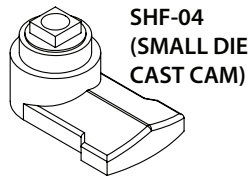

OPTION 2

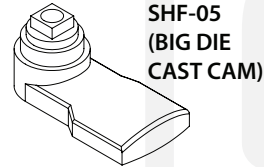

OPTION 3

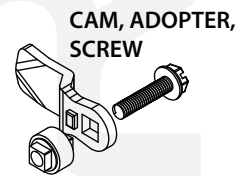

LATCH ROD STUD OPTIONS

OPTION 1

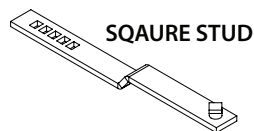

OPTION 2

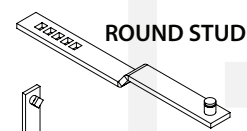

OPTION 3

